



BLAND & SORKIN
ATTORNEYS AT LAW

SCC-CLERK'S OFFICE
DOCUMENT CONTROL CENTER

2018 JUN 13 A 11:41

100020362

5398 TWIN HICKORY ROAD
GLEN ALLEN, VIRGINIA 23059

MAILING ADDRESS: PO BOX 25699
RICHMOND, VA 23260-5699

TELEPHONE (804) 747-6667
FACSIMILE (804) 747-6566
ssorkin@blandsorkin.com

June 13, 2018

By Hand Delivery

The Honorable Joel H. Peck
Clerk of the Commission
State Corporation Commission
Document Control Center
Tyler Building, 1300 E. Main Street
Richmond, Virginia 23219

Re: Re:Supplement to Amendment to Form A Statement Regarding the Acquisition of Control of Genworth Life and Annuity Insurance Company and Jamestown Life Insurance Company (the "Domestic Insurers") by China Oceanwide Holdings Group Co., Ltd. and certain of its affiliates ("China Oceanwide" or the "Applicants")
Case No.: INS-2016-00289

Dear Clerk Peck:

On behalf of China Oceanwide, enclosed for filing please find an original and fifteen (15) copies of an updated Exhibit 2(a) (Organizational Chart Prior to the Transaction) and Exhibit 2(b) (Organizational Chart Following the Transaction) supplementing the Amendment to the Form A Statement Regarding the Acquisition of Control of the Domestic Insurers (including exhibits) pursuant to Section 38.2-1323 of the Code of Virginia and 14 VAC 5-260 of the Virginia Administrative Code (the "Amended Application") filed with the State Corporation Commission (the "Commission") on June 1, 2018. Please let us know if additional copies of these updated Exhibits would be helpful to the Bureau of Insurance in its review of the Amended Application.

The above-mentioned Exhibits were updated due to changes to the organizational charts since the 1st Quarter of 2017, when previously updated organizational charts were last filed with the Commission. The Exhibits filed herewith reflect updated shareholding and affiliate information as of June 8, 2018 and supersede the information provided in earlier organizational charts filed with the Commission and in the Amended Application. The updated Exhibit 2(b) is a

Mr. Joel H. Peck
June 13, 2018
Page 2

180620362

simplified organizational chart that only indicates those China Oceanwide affiliates that would be in the chain of ownership of Genworth Financial, Inc. following consummation of the proposed acquisition; the second page of Exhibit 2(b) indicates the changes in shareholdings that have occurred among such Oceanwide affiliates since the date of the last organizational chart filed with the Commission.

I ask that the additional enclosed copy of this letter be file-stamped and returned to the deliverer of this filing for our records.

Should you have any questions or comments concerning this filing, please do not hesitate to contact me at (804) 747-6667 or by email at ssorkin@blandsorkin.com or Marion Leydier at (212) 558-7925 or by email at leydiem@sullcrom.com. We appreciate you and your staff's time and assistance with this filing and look forward to continuing to work with the Commission and the Bureau during the review process.

Very truly yours,

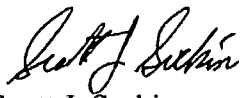

Scott J. Sorkin

Enclosures

cc: Douglas C. Stolte, Deputy Commissioner, Financial Regulation Division
Tanvi L. Parmar, Esq., Attorney II, Office of the General Counsel
Xiaoxia Zhao, China Oceanwide
Marion Leydier, Sullivan & Cromwell LLP

Exhibit 2(a)

Organizational Chart Prior to the Transaction

CHINA OCEANWIDE SIMPLIFIED ORGANIZATION STRUCTURE

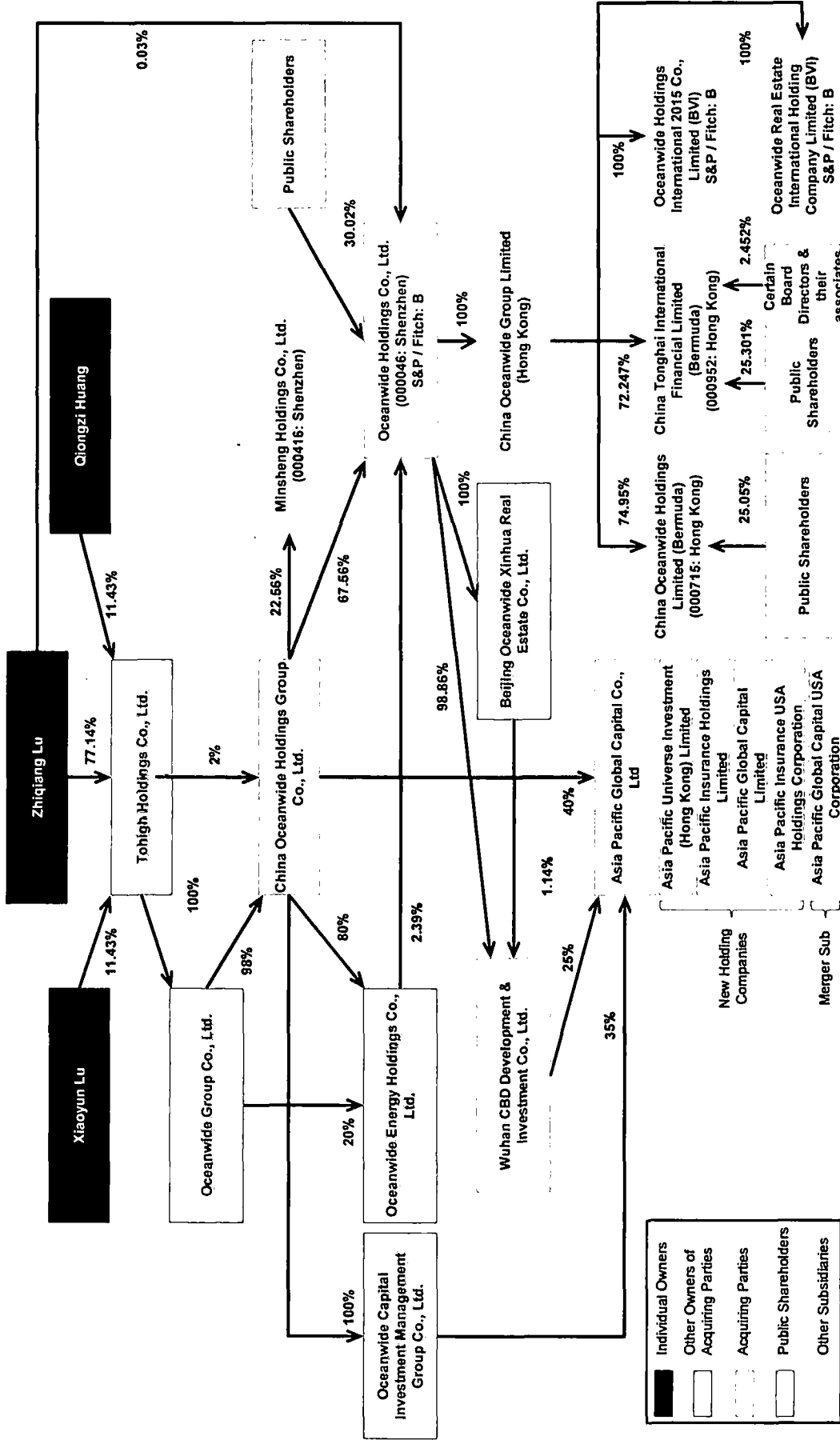

Note: 1. This is a simplified organization structure, certain intermediary holding companies and subsidiaries are not shown.
 2. The New Holding Companies and Merger Sub are only shown in this simplified organization structure.

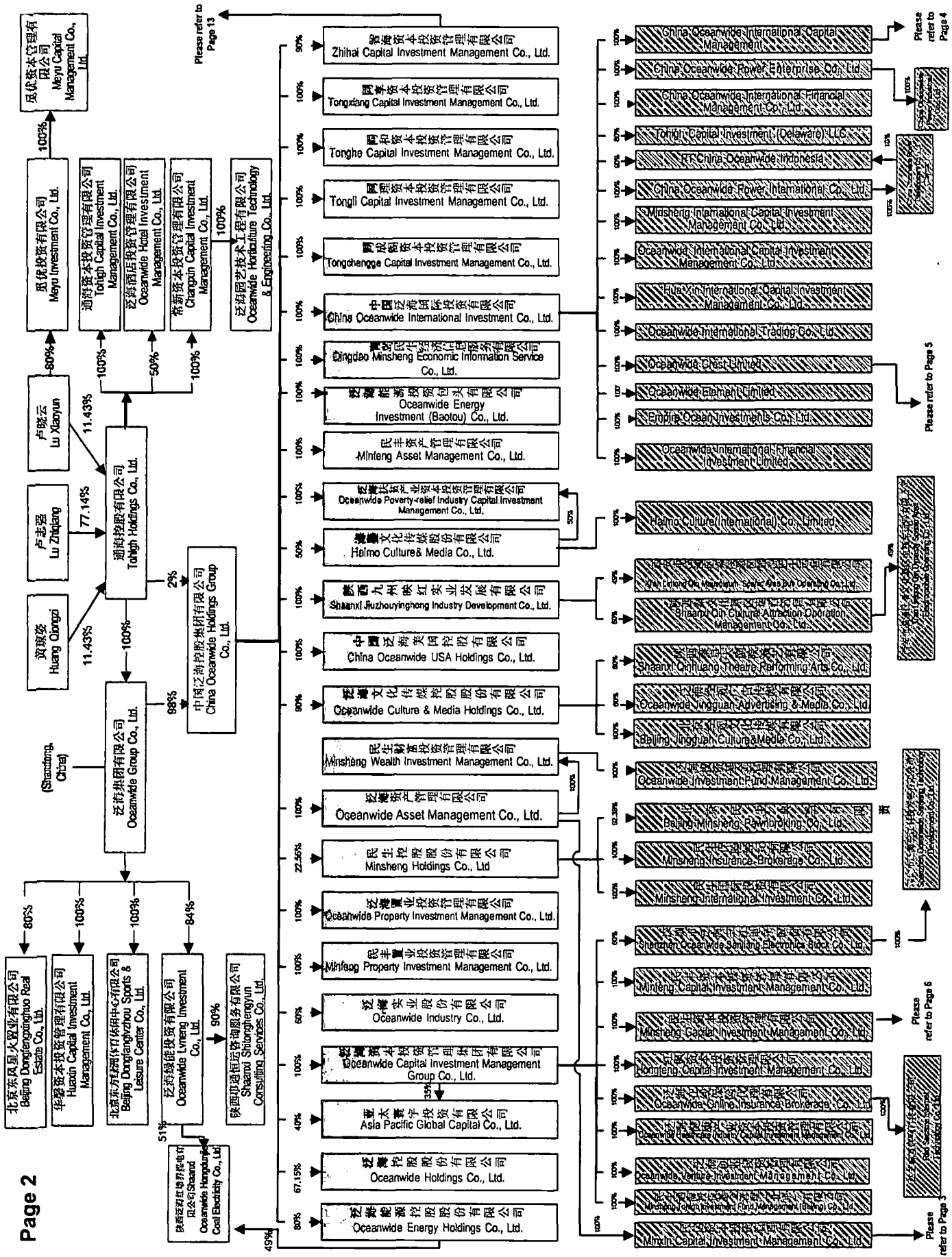

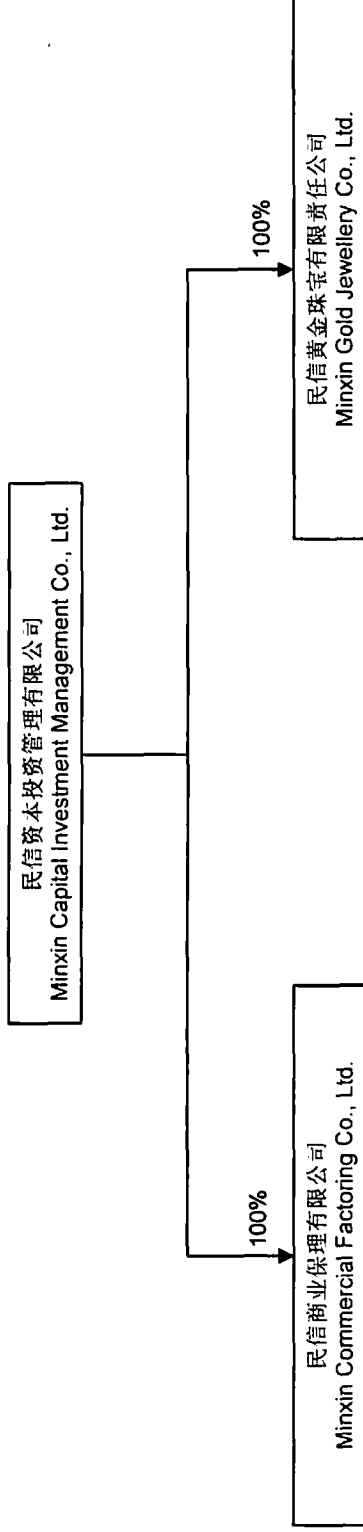

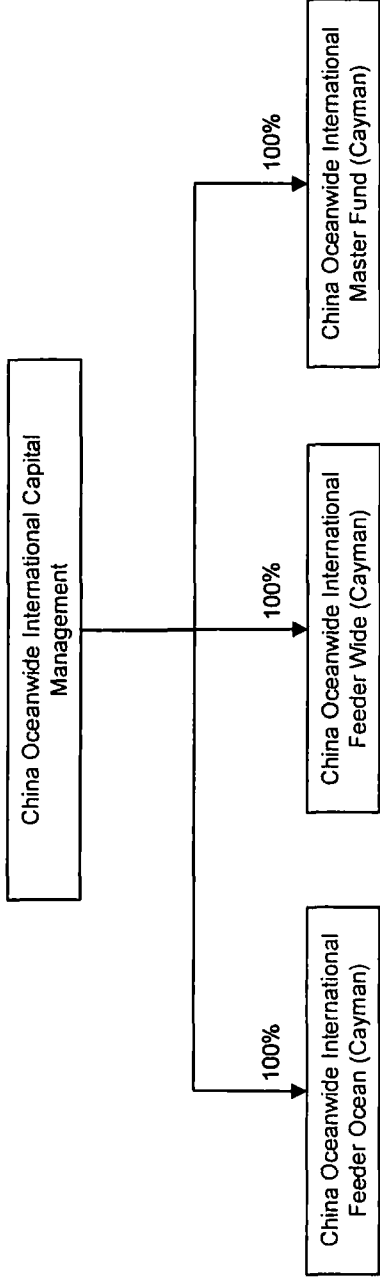

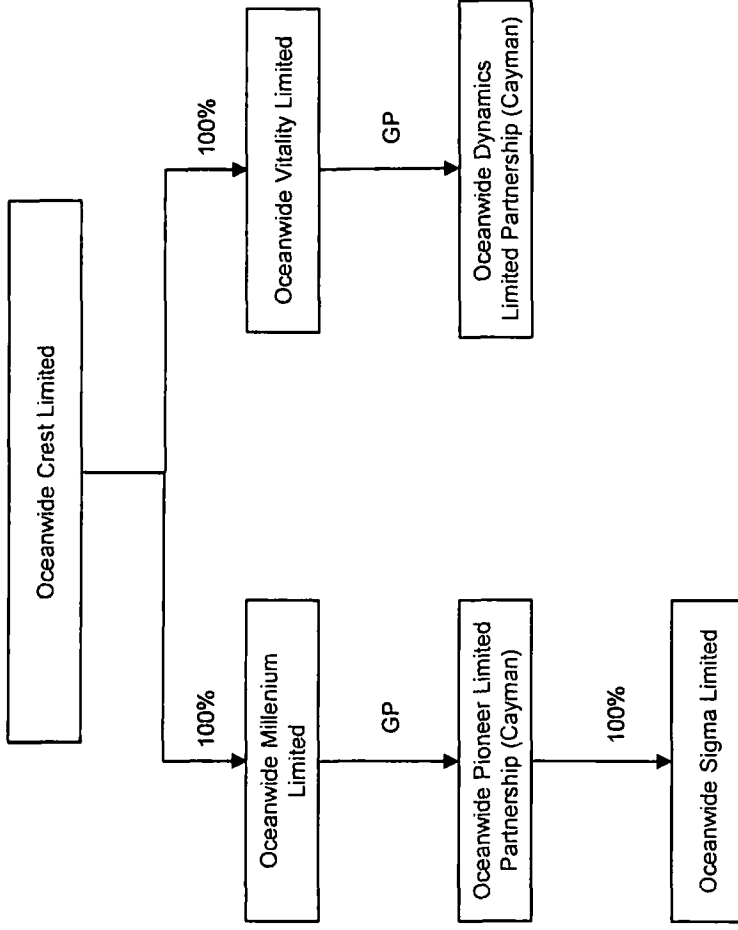

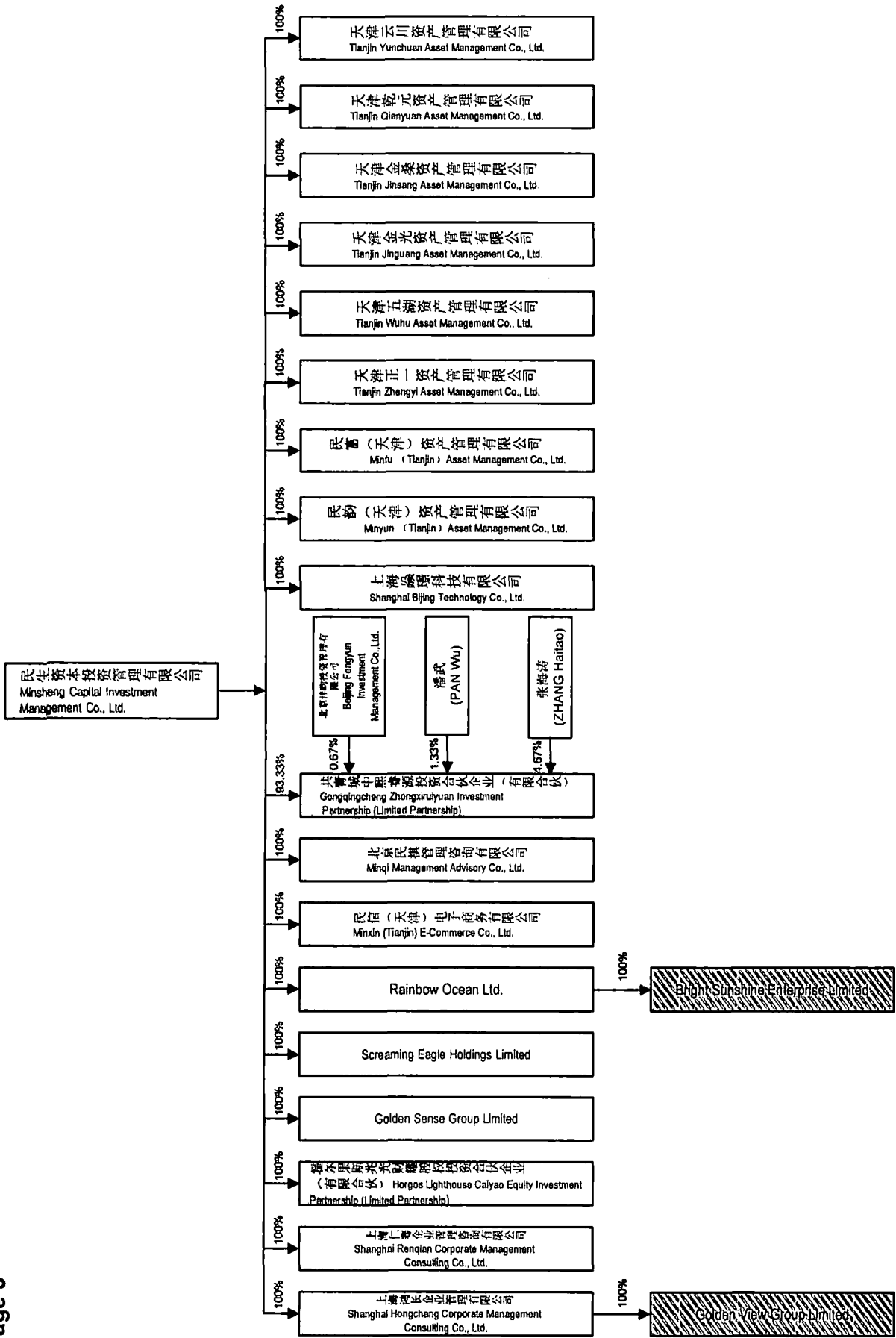

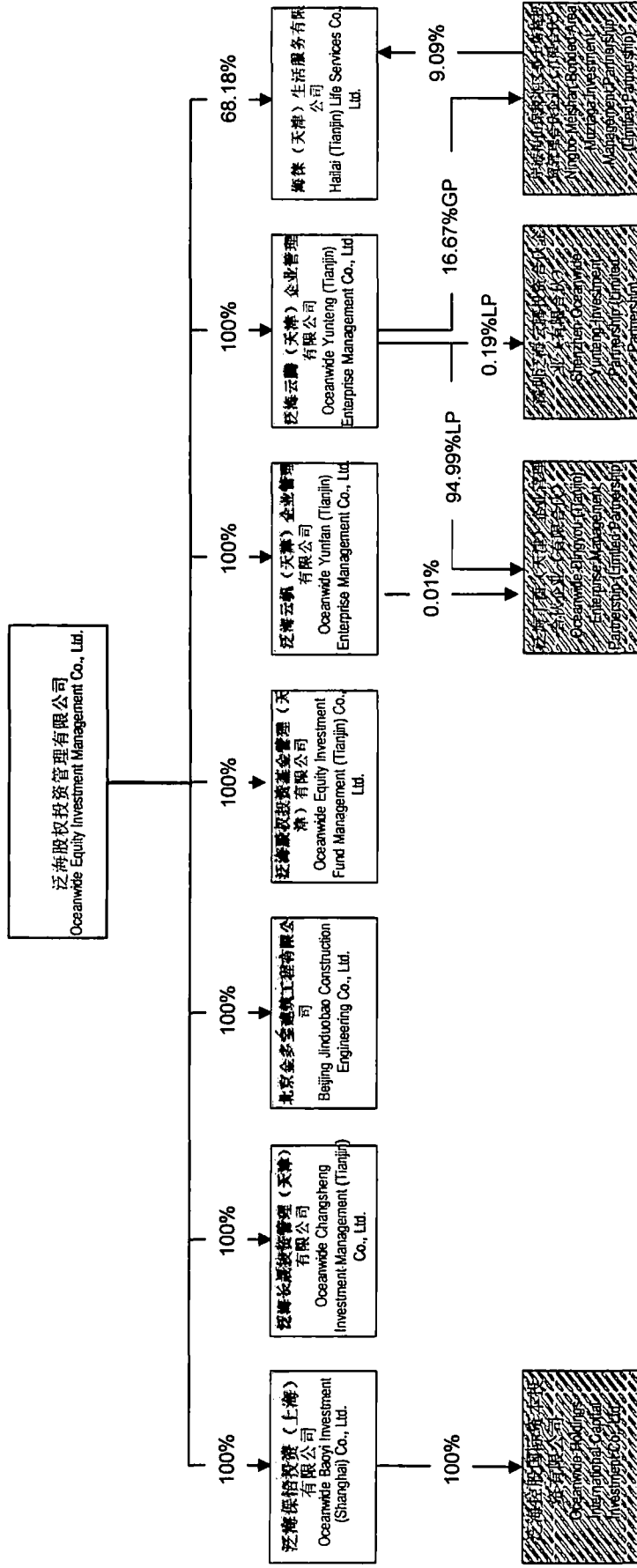

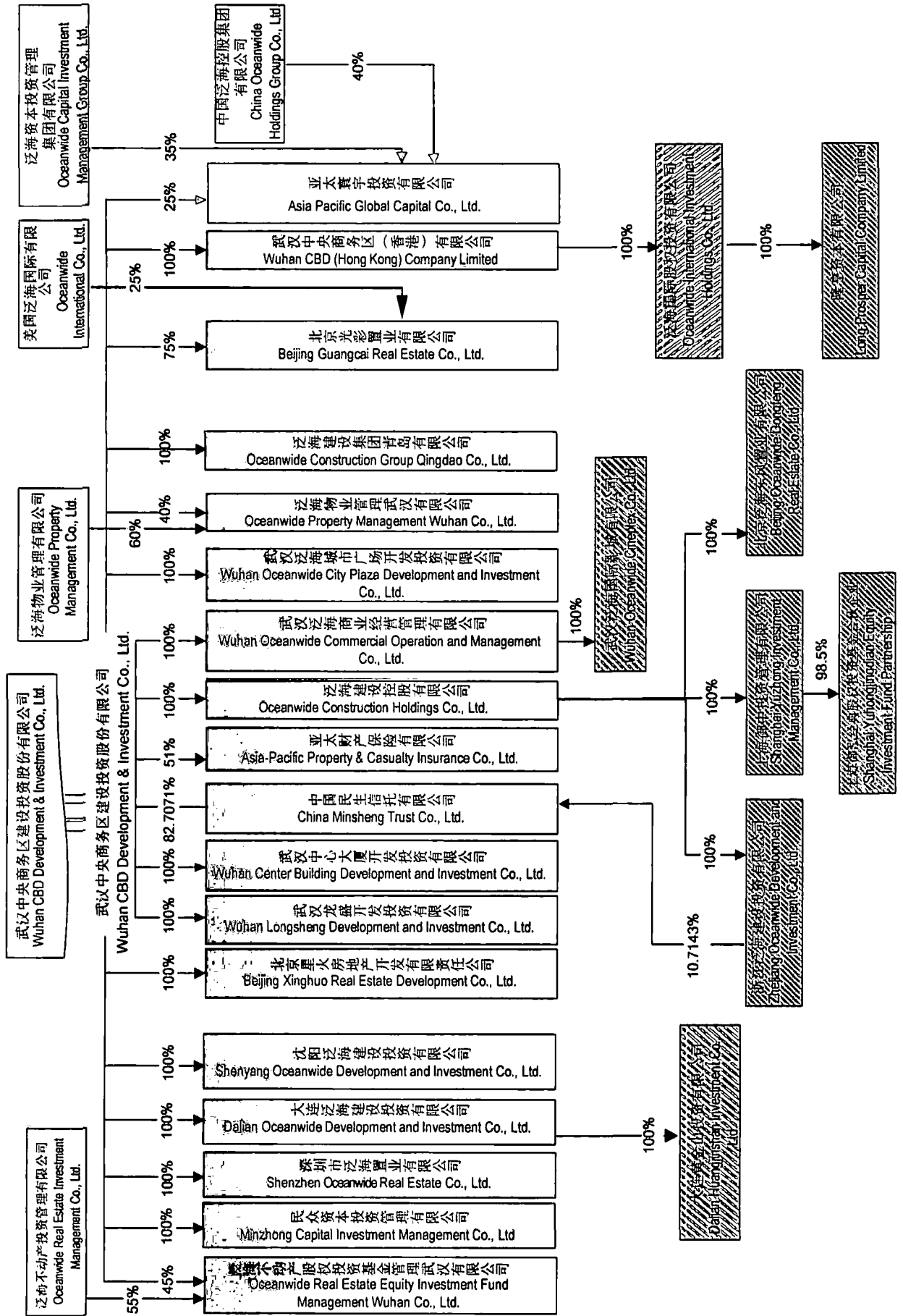

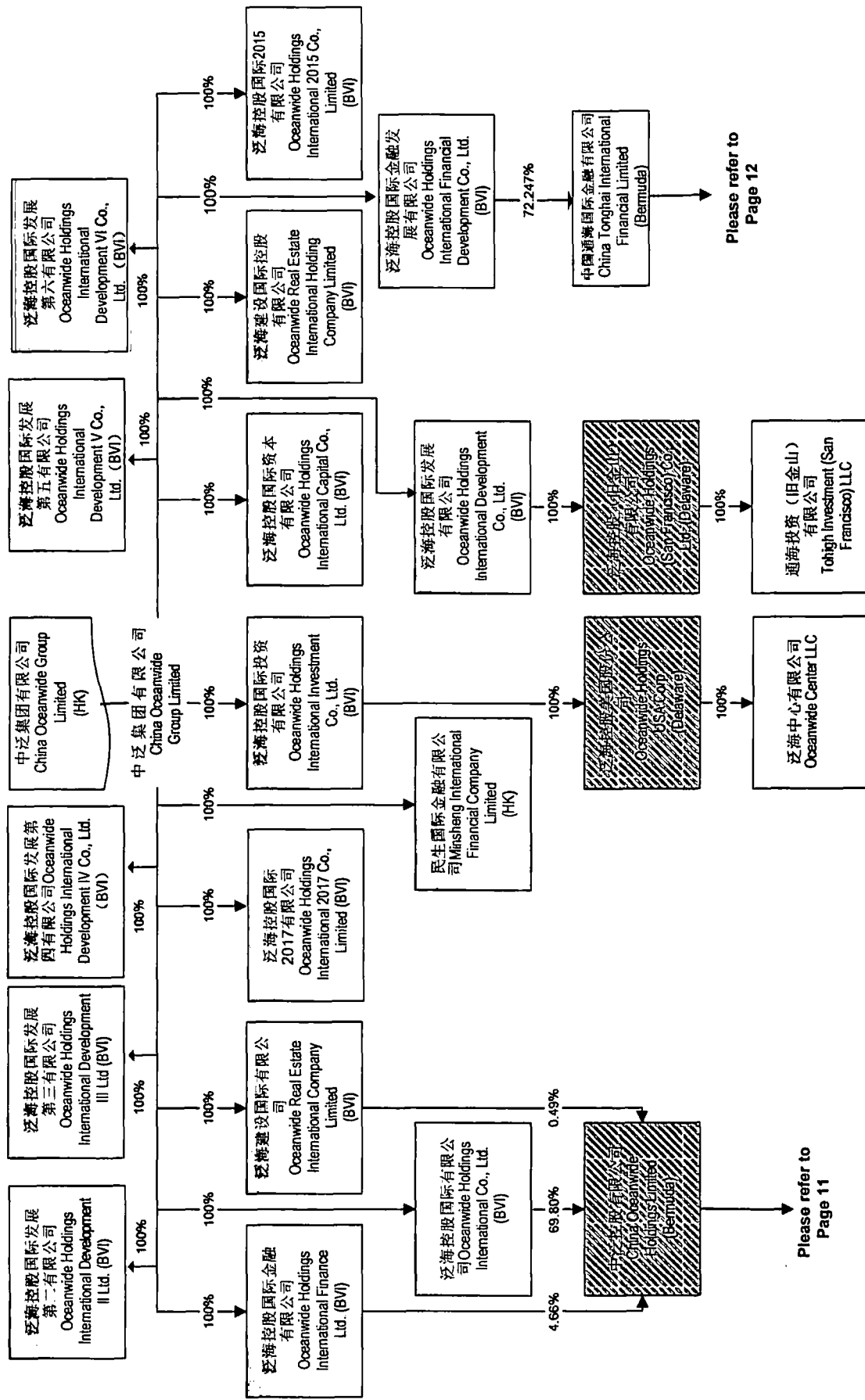

Please refer to Page 11

Please refer to Page 12

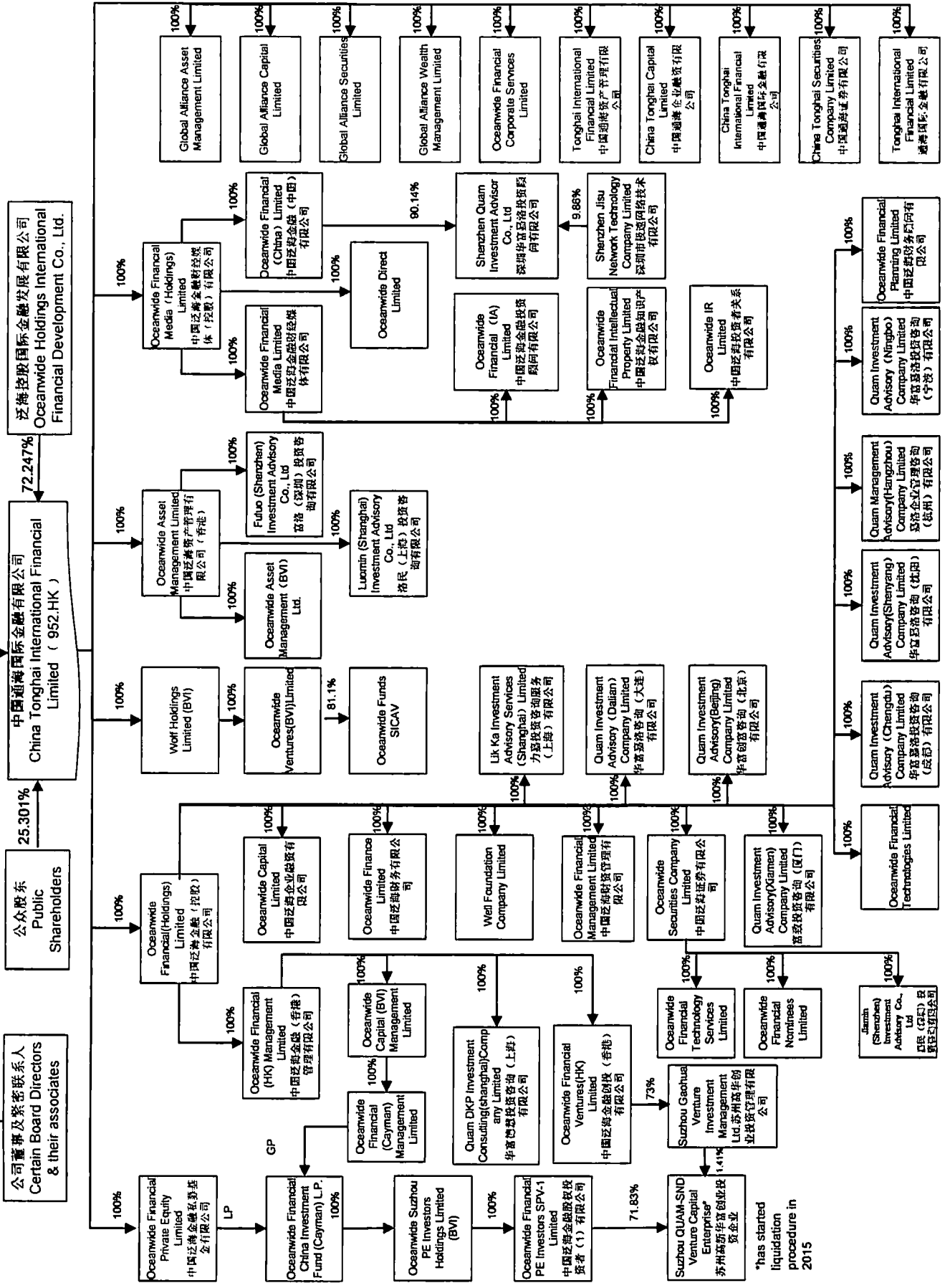

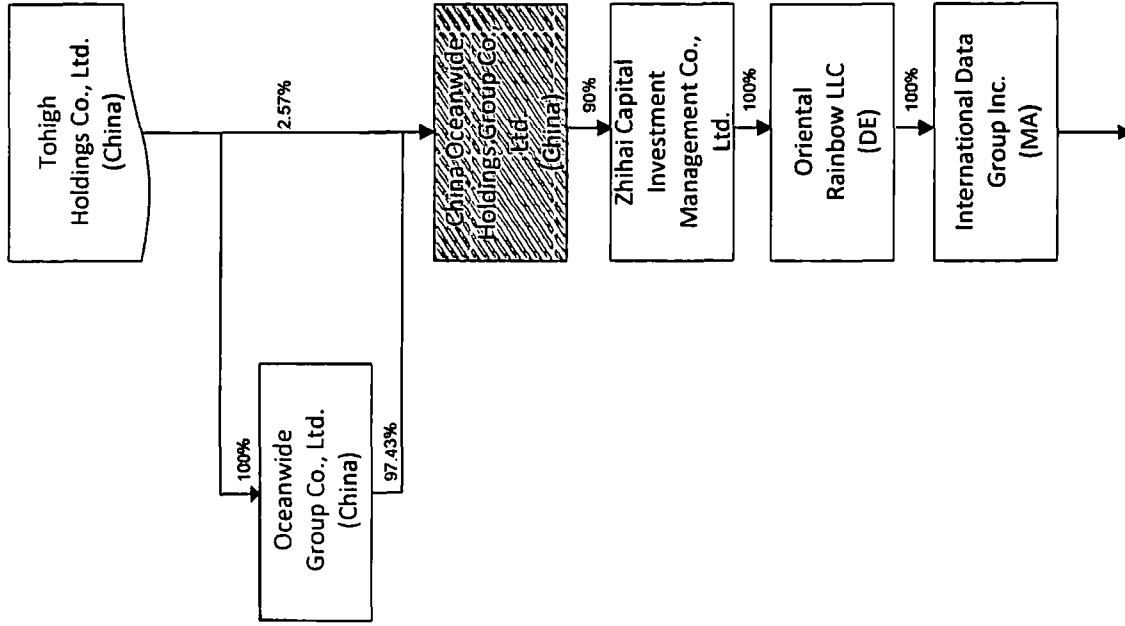

International Data Group, Inc.
(Ownership Structure)
(May 18, 2018)

Please refer to Page
14 and Page 15

International Data Group, Inc.
(U.S. Subsidiaries)
(May 18, 2018)

International
Data Group Inc.
(MA)

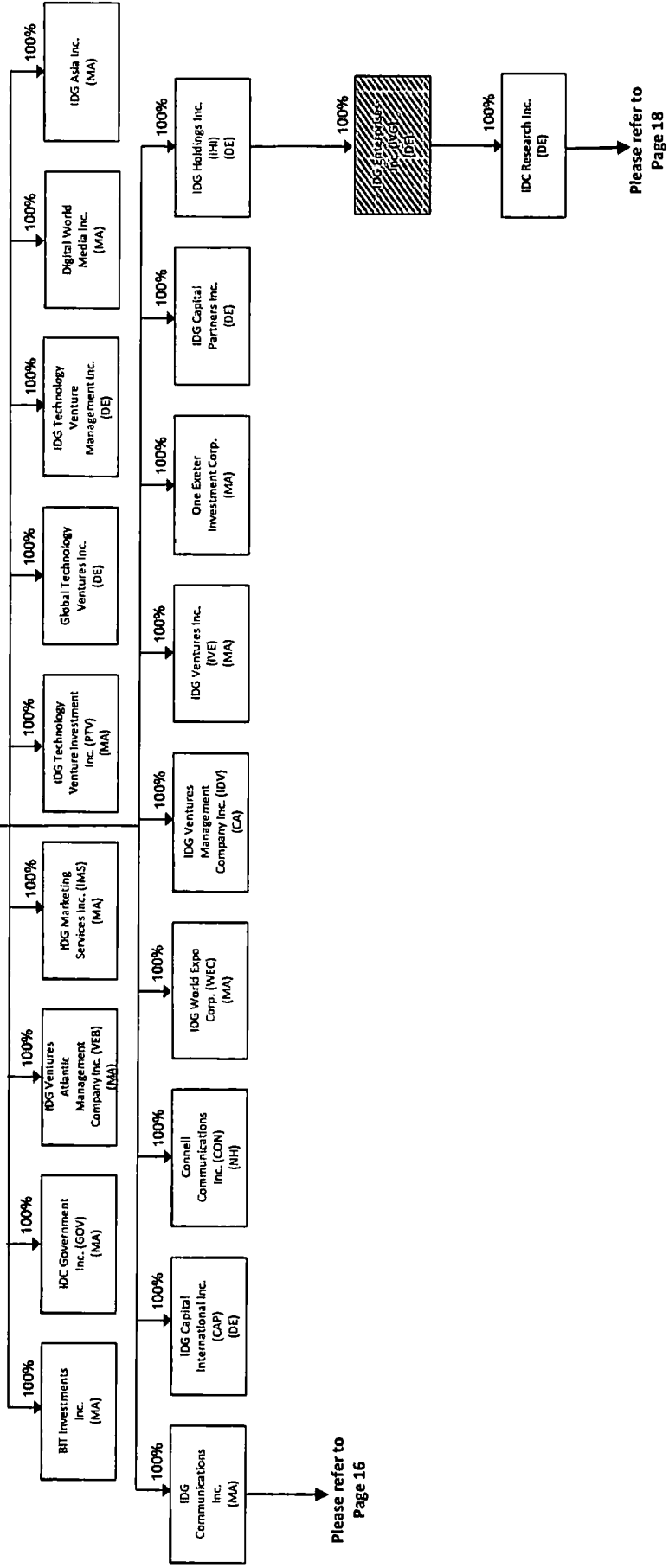

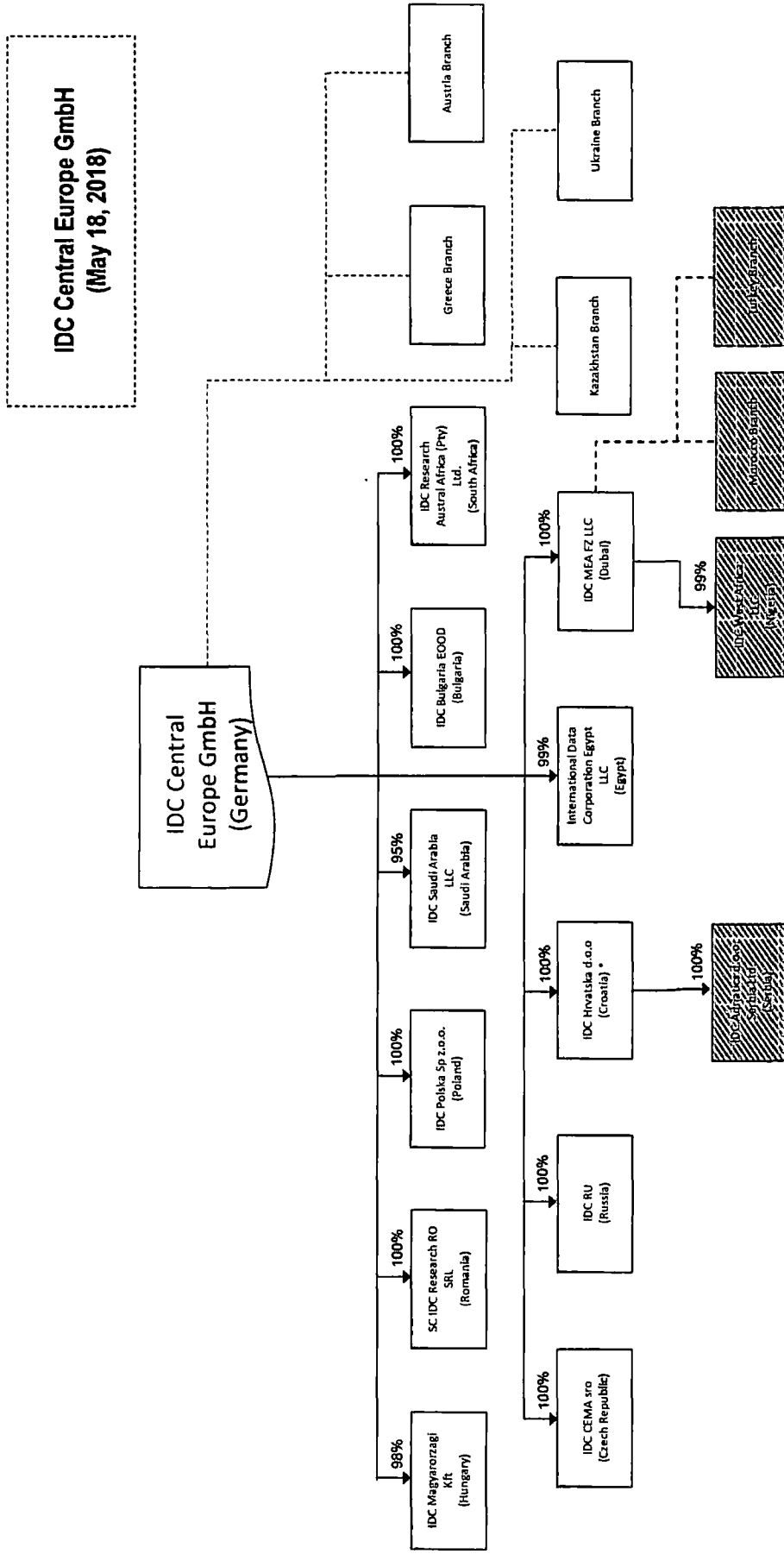
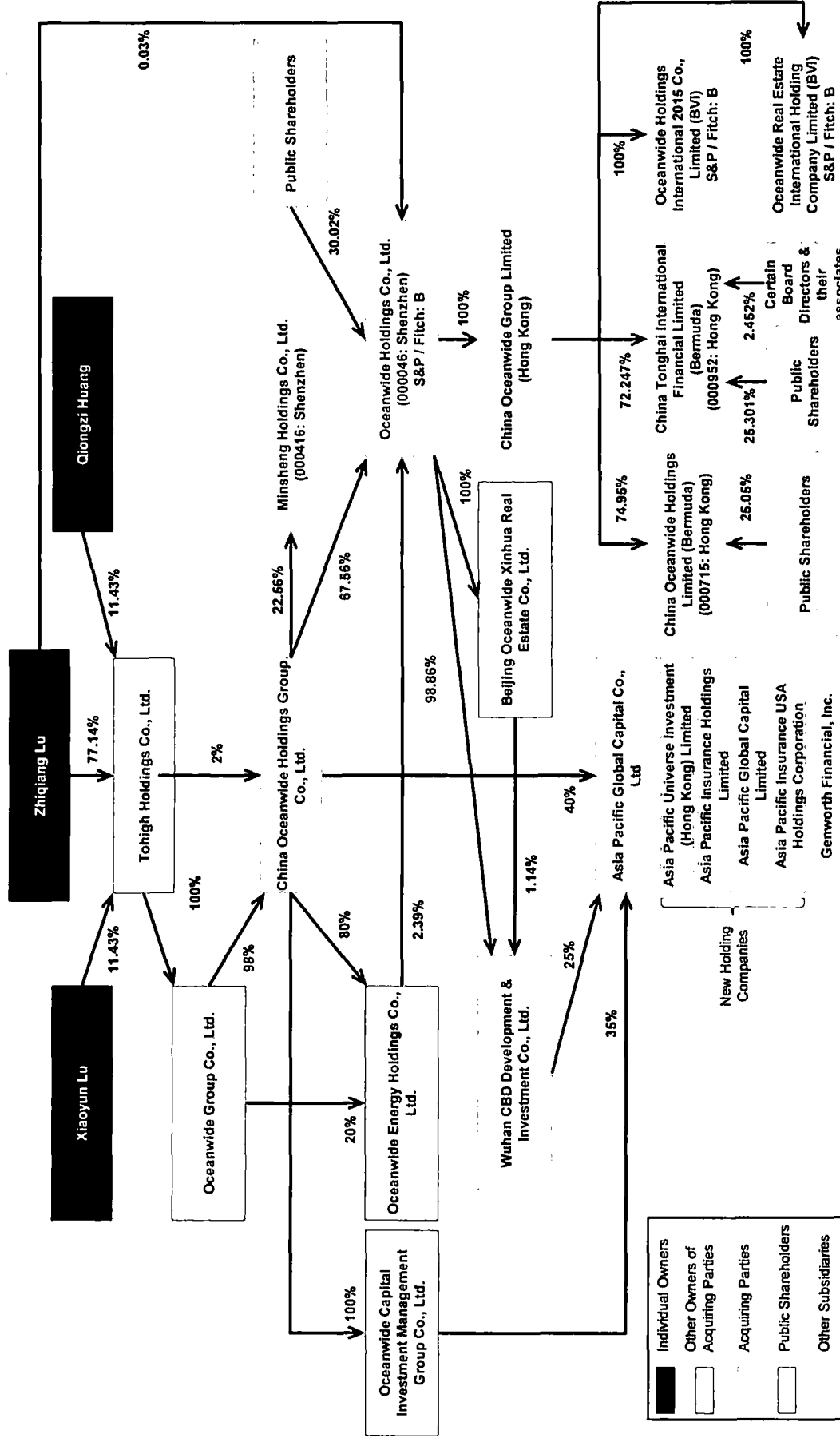

Exhibit 2(b)

Organizational Chart Following the Transaction

CHINA OCEANWIDE SIMPLIFIED ORGANIZATION STRUCTURE



Note: 1. This is a simplified organization structure, certain intermediary holding companies and subsidiaries are not shown.

CHINA OCEANWIDE SIMPLIFIED ORGANIZATION STRUCTURE

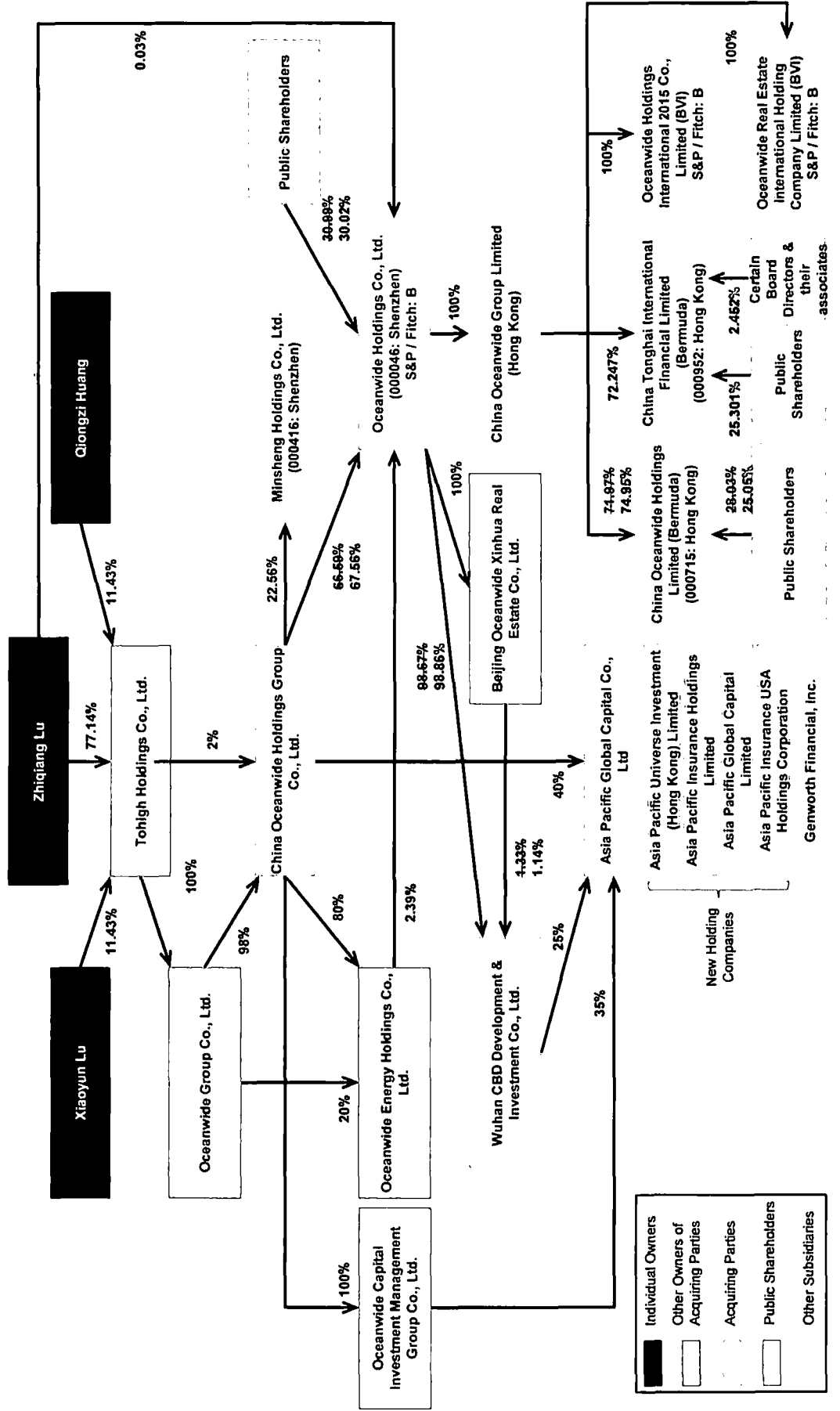

Note: 1. This is a simplified organization structure, certain intermediary holding companies and subsidiaries are not shown.